

Operation Guide DQR-200U

Main unit

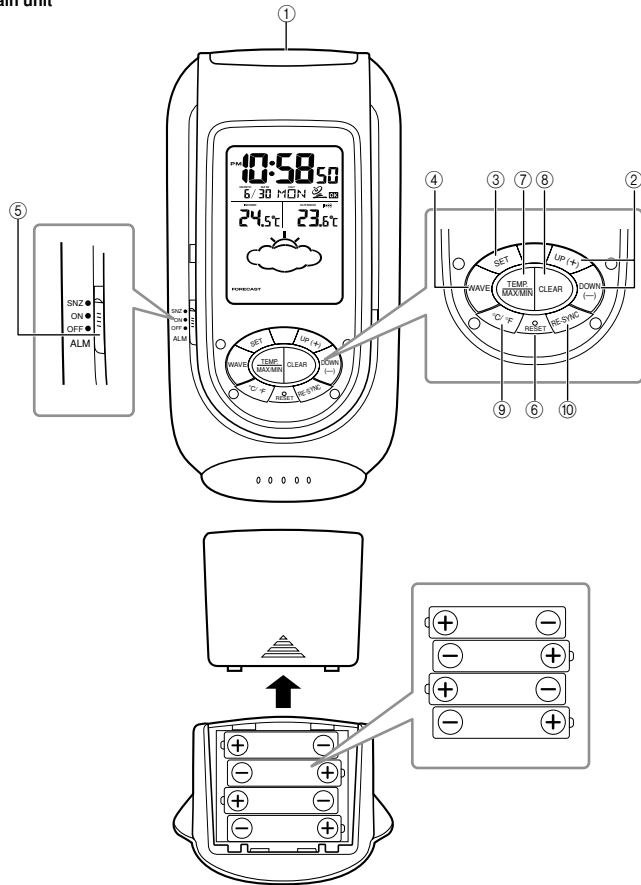

Sub-unit

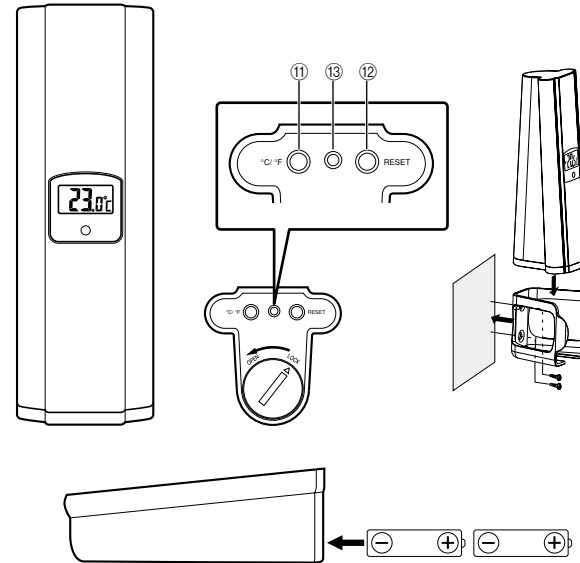

- A sticker is affixed to the glass of this clock when you purchase it. Be sure to remove the sticker before using the clock.
- Depending on the clock model, the configuration of your clock may differ somewhat from that shown in the illustration.

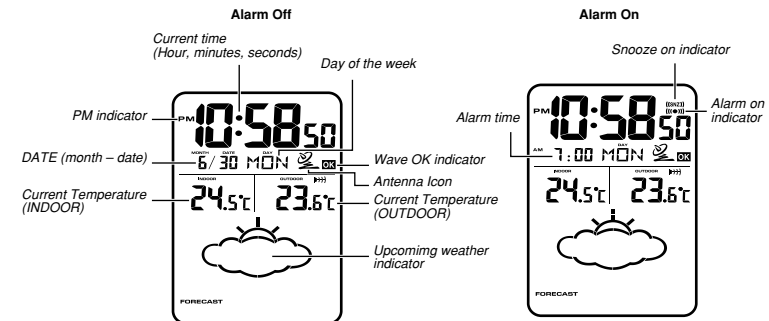

- In locations subject to radio frequency interference, the product may malfunction and require you to reset the product.

GENERAL GUIDE

Main unit

① SNOOZE/LIGHT button

- Press this button to illuminate the display for about four seconds.
- Pressing this button while the alarm is sounding stops the alarm.

② Alarm Time Set buttons

Use these buttons to change the alarm time or current time setting.

③ SET button

Use this button when setting the current time.

④ WAVE button

Press this button to receive the time calibration signal and adjust timekeeping.

⑤ Alarm Mode selector

SNZ: Snooze alarm on
ON: Alarm on
OFF: Alarm off

⑥ RESET button

Press this button to reset the clock after replacing its batteries.

⑦ MAX/MIN TEMP. button

Press this button to display the high and low temperature values.

⑧ CLEAR button

Press this button to clear the currently displayed high/low temperature.

⑨ °C/ °F button

Press this button to toggle the temperature units between Celsius and Fahrenheit.

⑩ RE-SYNC button

Press this button to re-synchronize the timing of the main unit and the sub-unit.

Sub-unit

⑪ °C/ °F button

Press this button to toggle the temperature units between Celsius and Fahrenheit.

⑫ RESET button

Press this button to reset the sub-unit after replacing its batteries.

⑬ TEST button

This button is for testing the unit. Normally, you should not press it. If you do, be sure to press the **RESET button** (⓫) next.

TIME CALIBRATION SIGNAL RECEPTION PRECAUTIONS

• This clock is able to receive the time calibration signal transmitted from Rugby, England. Signal reception is possible within approximately 1,000 km of the transmitter.

• Even when the clock is within the reception range, signal reception is impossible if the signal is blocked by mountains or other geological formations between the clock and signal source.

• Signal reception is affected by weather, atmospheric conditions, and seasonal changes.

• The time calibration signal is bounced off the ionosphere. Because of this, such factors as changes in the reflectivity of the ionosphere, as well as movement of the ionosphere to higher altitudes due to seasonal atmospheric changes or the time of day may change the reception range of the signal and make reception temporarily impossible.

• Reception is best when the back of the clock is facing toward Rugby. Note, however, that moving the clock while the time calibration signal receive operation is taking place will make stable reception impossible.

• Think of the clock as acting like a TV or radio when it is receiving the calibration signal. When receiving indoors, move to a location as near as possible to a window. Proper signal reception can be difficult or even impossible under the conditions listed below.

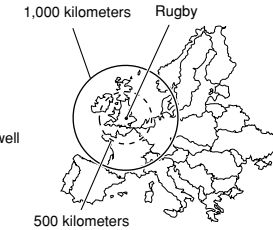

Inside, among buildings, or near neon signs

Inside a vehicle

Near refrigerators or other household appliances, near office equipment, mobile phones or wireless LAN devices.

Near a construction site, airport, or other sources of electrical noise, underground or in tunnels, near railroads, highways, or radio stations with interfering frequencies.

Near high-tension power lines

Among or behind mountains

- Signal reception is normally better at night than during the day.
- Radio interference can make signal reception impossible.
- Strong electrostatic charge can result in the wrong time being set.
- The alarm does not operate during signal reception.

USING THE CLOCK

Any of the following procedures can be used to set current date and time.

- Auto receive of the time calibration signal
- Manual receive of the time calibration signal
- Manual setting without using the time calibration signal

Auto Receive

- The clock receives the time calibration signal eight times each day (1:00, 4:00, 7:00, 10:00, 13:00, 16:00, 19:00, 22:00).
- A signal receive operation takes from two to ten minutes under good signal conditions.
- A receive indicator shows the current status of the receive operation.

Antenna Icon

Receive in progress: Icon flashes
 Receive failed: Icon not displayed
 Receive successful: Icon displayed

Wave OK Indicator

Receive in Progress: OK not displayed
 All receives over the past 24 hours failed: OK not displayed
 At least one successful receive over the past 24 hours: OK displayed

Unsuccessful Signal Reception

The antenna icon disappears from the display when a signal receive operation is unsuccessful. If this happens, try changing the position or orientation of the clock, and press the **WAVE button** (④) to receive again.

Manual Receive

- Press the **WAVE button** (④) to start a calibration signal receive operation.
- Use the **WAVE button** (④) to perform a receive operation after replacing the clock's batteries or if the auto receive operation was not performed correctly for some reason.
- The clock beeps and display illumination flashes for about three seconds when a receive operation triggered by the **WAVE button** (④) is successful.

Important!

- Do not perform any button or switch operation while a signal receive operation is in progress.
- The time calibration signal includes both Standard Time and Daylight Saving Time (summer time) data.
- The DST indicator appears on the display when Daylight Saving Time (summer time) data is received.

Setting the Time and Date Manually

- When using the clock in an area that is outside of the range of the transmitter in Rugby or in an area where signal reception is impossible for some reason, you need to manually adjust the time as required.
1. Press the **SET button** (③) to cycle through the setting screens as shown below.

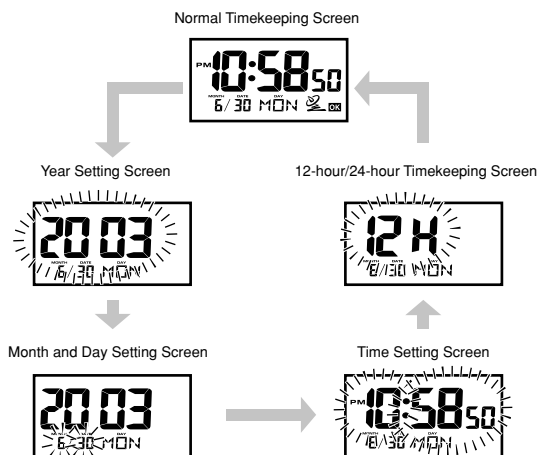

2. While the screen you want is on the display, use the **Alarm Time Set buttons** (②) to change the digits that are flashing.



- Holding down + or - changes the flashing digits at high speed.
 - You can set the year in the range of 2000 to 2039. The day of the week is set automatically in accordance with the date setting.
 - Pressing + or - while the Time Setting Screen is on the display causes the seconds count to be reset to 00.
 - Each press of + or - while the 12-hour/24-hour Timekeeping Screen is on the display toggles between 12-hour and 24-hour timekeeping.
3. After making the settings you want, use the **SET button** (③) to display the Normal Timekeeping Screen.
- The clock automatically returns to the Normal Timekeeping Screen if you leave a setting screen on the display for about three minutes without performing any operation.

USING THE ALARM

The alarm sounds and the light turns on when the alarm time you set is reached. You can also use the **Alarm Mode selector** (⑤) to select the snooze alarm feature.

Setting the Alarm Time

Use the **Alarm Time Set buttons** (②) to set the alarm time. Pressing the **Alarm Time Set buttons** (②) causes the alarm time to appear in place of the date on the display.



- Holding down + or - changes the digits at high speed.

Turning the Alarm On and Off

Use the **Alarm Mode selector** (⑤) on the side of the clock to turn the alarm on and off, and to select the snooze feature.

Alarm Mode selector	Description
SNZ ((SNZ)) (((●)))	The alarm sounds at the preset time for one minute, and seven more times every five minutes thereafter. Even if you stop the alarm sound by pressing the SNOOZE/LIGHT button (①), the alarm operation is performed again five minutes later. • The indicator ((SNZ)) flashes on the display to indicate that the snooze feature is activated.
ALM ON (((●)))	The alarm sounds at the preset time for one minute.
ALM OFF	The alarm does not sound.

- The alarm time appears in place of the date on the display whenever the **Alarm Mode selector** (⑤) is set to ON or SNZ.
- The light also turns on for the first four seconds that the alarm sounds.
- The alarm sound changes over four levels as it sounds.

Stopping the Alarm

- When alarm is sounding, press the **SNOOZE/LIGHT button** (①) to stop it. When the snooze feature is turned on, the alarm will sound again in about five minutes.
- To turn off the snooze feature, slide the **Alarm Mode selector** (⑤) to OFF.

USING THE LIGHT

Pressing the **SNOOZE/LIGHT button** (①) turns on the light and illuminates the display for easy reading in the dark.

Important!

- Overuse of the light can shorten battery life.

BATTERY REPLACEMENT

Low Battery Warning

A indicator appears on the display to let you know when battery power is low. Replace the batteries as soon as possible.

Note that the indicator appears on both the main unit and sub-unit when sub-unit battery power goes low.

To replace main unit batteries

Replace batteries whenever the display of the clock becomes dim and difficult to read.

1. Open the battery compartment cover as shown in the illustration.
2. Remove all of the old batteries.
3. Load a full set of new batteries. Make sure that their positive (+) and negative (-) ends face in the correct directions. If you load batteries incorrectly, they can burst and damage the clock.
4. Replace the battery compartment cover.
5. Press the **RESET button** (⑥). Be sure to press the **RESET button** (⑥) after replacing batteries.

To replace sub-unit batteries

1. Rotate the battery compartment cover from LOCK to OPEN.
2. Remove both old batteries.
3. Load new batteries. Make sure that their positive (+) and negative (-) ends face in the correct directions. If you load batteries incorrectly, they can burst and damage the clock.
4. Replace the battery compartment cover.
5. Press the **RESET button** (②). Be sure to press the **RESET button** (②) after replacing batteries.
6. Press the **RE-SYNC button** (⑩).

Battery precautions

- Keep batteries out of the reach of small children. If a battery is accidentally swallowed, contact your physician immediately.
- Be sure to load the batteries with their positive (+) and negative (-) ends facing correctly.
- Never mix old and new batteries, or batteries of different brands.
- Never charge the batteries that come with the clock.
- Should batteries ever leak while in the clock, wipe out the fluid with a cloth, taking care not to let any get onto your skin.
- Replace the batteries at least once a year, even if the current batteries are working properly.
- The batteries that come with the clock lose some of their power during transport and storage.

THERMOMETER FUNCTIONS

Both the main unit and the sub-unit are equipped with their own temperature sensors. Temperature data measured by the sub-unit is sent by wireless transfer to the main unit. This makes it possible to view both the indoor and outdoor temperature on the main unit display.

Temperature Measurements

- Both the main unit and the sub-unit take temperature measurements every 16 seconds.
- The temperature display shows "LO" for temperatures below -50°C (-58°F) and "HI" for temperatures above 70°C (158°F).
- Though temperature readings are displayed up to 0°C (32°F) and greater than 41°C (105°F), note that such readings are actually outside the guaranteed temperature range of this clock.

Switching between Celsius and Fahrenheit

- Push the **$^{\circ}\text{C}/^{\circ}\text{F}$ button** (⑨) to select either Celsius ($^{\circ}\text{C}$) or Fahrenheit ($^{\circ}\text{F}$).

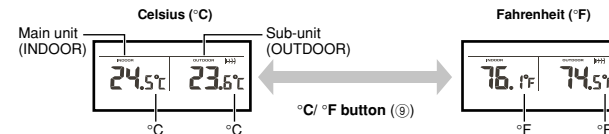

High Temperature and Low Temperature Memory

- The following data is stored in memory automatically.
Main unit high temperature and low temperature
Sub-unit high temperature and low temperature

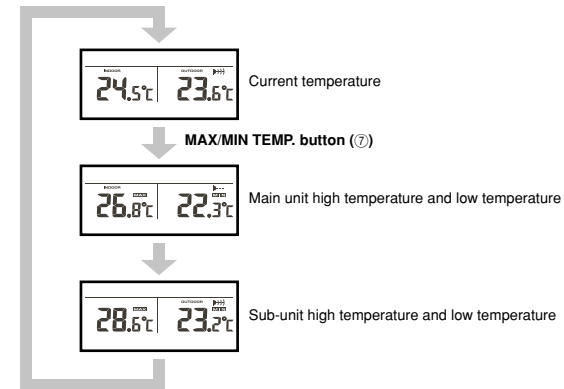

- To clear the high temperature and low temperature data memory, press the **CLEAR button** (⑧). New data starts to be stored after memory is cleared.

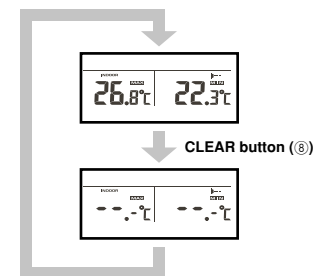

Operation Guide DQR-200U

CASIO®

USING THE SUB-UNIT

Data Transfer from the Sub-unit

- Data is transferred from the sub-unit to the main unit every three minutes.
- The sub-unit is able to send data to the main unit up to an unobstructed distance of about 30 meters.
- The data receive status is indicated on the display of the main unit by the icons shown below.

Receive successful



Receive unsuccessful



- If a receive operation is not successful for some reason, the display of the main unit shows dashes (-) in place of the sub-unit temperature value.
- If you experience problems with data transfer, press the **RE-SYNC button** (Ⓜ) to synchronize the two units. If this does not eliminate the problem, try changing the positions or orientations of the main unit and sub-unit.

Switching between Celsius and Fahrenheit

- Push the **°C/°F button** (Ⓜ) to toggle between Celsius (°C) and Fahrenheit (°F).

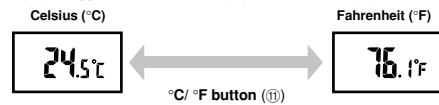

Location

- Place the sub-unit in a location where it will not be exposed to rain, direct sunlight, or other elements.

USING THE WEATHER FORECAST FEATURE

A built-in pressure sensor makes it possible to forecast upcoming weather over the next 12 hours based on changes in barometric pressure. Note that these forecasts are not absolutely accurate, and are intended for general reference only.

Weather Forecasts

- Barometric pressure readings are taken every 15 minutes. Weather forecasts are based on the last six readings. Upcoming weather forecasts are displayed using the graphic indicators shown below.

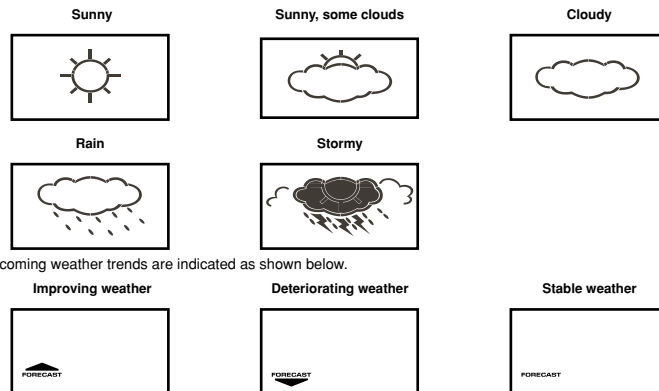

- Upcoming weather trends are indicated as shown below.

MAIN UNIT/SUB UNIT COMMUNICATION PRECAUTIONS

Sub Unit Location

- Certain environmental conditions can greatly reduce the communication range.
- Avoid the following locations for the sub-unit.



Inside, among buildings, or near neon signs



Inside a vehicle

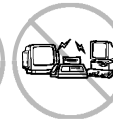

Near refrigerators or other household appliances, near office equipment, mobile phones or wireless LAN devices.

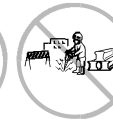

Near a construction site, airport, or other sources of electrical noise, underground or in tunnels, near railroads, highways, or radio stations with interfering frequencies.



Near high-tension power lines

- Locating the sub-unit near a device that transmits radio signals using the same frequency as this product can cause communication failure of this product.
- Avoid using multiple products in the same area. Doing so can cause mixing of their signals.

RADIO, EMC AND SAFETY REGULATIONS

This product complies with technical specifications required under EN 301 489-3, EN 300-220-3 and EN 60950.